

KRAMER



USER MANUAL

MODEL:

FC-6

Ethernet Gateway - RS-232/IR



Scan for full manual

FC-6 Quick Start Guide

This guide helps you install and use your FC-6 for the first time.

Go to www.kramerav.com/downloads/FC-6 to download the latest user manual and check if firmware upgrades are available.

Step 1: Check what's in the box

- FC-6 Ethernet Gateway
- 4 Rubber feet
- 1 Bracket set
- 1 USB A to USB mini cable
- 1 Quick start guide

Step 2: Get to know your FC-6

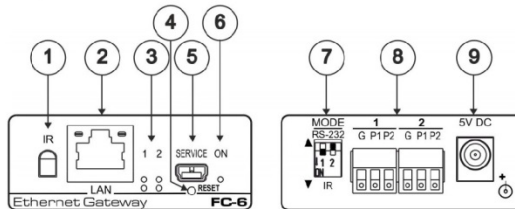

#	Feature	Function
1	IR Sensor	Sensor for IR learning
2	LAN RJ-45 Connector	Connects to an IP client or other controller, either directly or via a LAN
3	Port 1 and 2 white (upper) and blue LEDs	Show the transmission status of port 1 and port 2: When set as RS-232, the white LED indicates Tx and blue LED indicates Rx When set as IR, the white LED indicates IR-P1 Tx and blue LED indicates IR-P2 Tx
4	RESET Button	Press and hold while cycling the device power to reset to factory default parameters
5	SERVICE Mini USB Connector	Connects to a USB power source for powering and to a PC for a local firmware upgrade
6	ON LED	Lights green when the unit is powered on
7	MODE DIP-switches (Port 1 and Port 2)	Switch up for RS-232, switch down for IR The default setting is port 1 RS-232 (up) and port 2 IR (down)
8	Port 1 and 2 I/O 3-pin Terminal Block	Each terminal block connects one bidirectional RS-232/RS-485 port or two IR outputs
9	5V DC Connector	Connects to an optional 5V DC power supply, center pin positive. Not needed when the device is supplied power by a USB power source

Step 3: Install the FC-6

You can mount this Kramer **PicoTOOL™** next to a USB power source behind an AV device, in room ceiling area, on a **desk top**, wall or similar area. Install FC-6 using one of the following methods:

- Attach the rubber feet and place the unit on a flat surface.
- Fasten a bracket (included) on each side of the unit and attach it to a flat surface. For more information go to www.kramerav.com/downloads/FC-6.
- Mount the unit in a rack using an optional RK-4PT rack adapter.

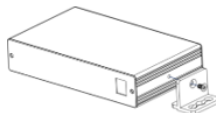

Step 4: Connect the inputs and outputs

Always switch OFF the power on each device before connecting it to your FC-6. For best results, we recommend that you always use Kramer high-performance cables to connect controlled equipment to the FC-6.

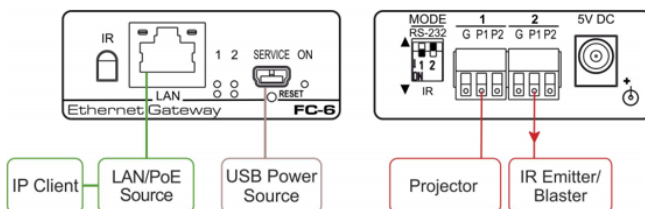

Step 5: Connect the power

Connect a USB power source and/or an optional 5V DC power supply to the FC-6 and plug it into the mains electricity.

Safety Instructions



- Caution:** There are no operator serviceable parts inside the unit.
Warning: Use only the Kramer Electronics power supply that is provided with the unit.
Warning: Disconnect the power and unplug the unit from the wall before installing.
See www.kramerav.com for updated safety information.

Step 6: Configure and operate the FC-6

Note: The FC-6 arrives with the default IP 192.168.1.39. To connect the FC-6 on first installation, you must identify what IP address has been automatically assigned to the FC-6. To discover the IP address of FC-6, use **K-LAN Configurator**, available for download from our website at www.kramerav.com.

To reset the device to its factory default settings:

1. Turn off the power to the device.
2. Press and hold the Reset button on the front panel.
3. Turn on the power to the device while holding down the Reset button for a few seconds.
4. Release the button.
The device is reset to the factory default settings.

To browse the FC-6 Web UI (User Interface) using factory default settings:

Use the default host name: FC-6-xxxx, where **xxxx** are the last four digits of the serial number of the device.

To configure and operate the FC-6:

1. Using the device Web UI, configure the control gateway:
 - Set DHCP or assign a static IP address
 - Associate IP port(s) with the relevant port(s)
 - Configure the relevant port parameters
2. Configure IP client connection port(s) on a Kramer control or any other control software application.
3. Set the control application to use the control gateway ports for sending and receiving control communication over the IP connections.

Contents

1	Introduction	1
2	Getting Started	2
2.1	Achieving the Best Performance	2
2.2	Safety Instructions	2
2.3	Recycling Kramer Products	3
3	Overview	4
4	Defining the FC-6 Ethernet Gateway - RS-232/IR	6
5	Performing Initial Configuration	8
5.1	Configuring the FC-6 Ethernet Gateway - RS-232/IR	8
5.2	Setting Up an Ethernet Connection on the PC	10
6	Connecting the FC-6	11
6.1	Connecting via Ethernet	12
7	Remote Operation via the Web UI	17
7.1	Browsing the Web UI	17
7.2	Displaying Connected Clients	19
7.3	Setting Device Name and Time Functions	20
7.4	Setting Communication Parameters	22
7.5	Setting Serial Port Parameters	23
7.6	Configuring IR Command Learning	24
7.7	Activating Security	25
7.8	Using the Logs Page	27
7.9	Kramer Information	28
8	Using FC-6 Operations	29
8.1	IR Learning	29
8.2	Resetting to the Factory Default Settings	30
8.3	Upgrading the Firmware	30
9	Technical Specifications	31
9.1	Data Handling Performance	32
9.2	Example Bandwidth Calculation	32
10	Default Communication Parameters	33
11	Kramer Protocol 3000	34
11.1	Kramer Protocol 3000 – Syntax	35
11.2	Kramer Protocol 3000 – Command List	38
11.3	Kramer Protocol 3000 – Detailed Commands	39

Figures

Figure 1: FC-6 Controlled Devices from Remote IP-based Clients	5
Figure 2: FC-6 Ethernet Gateway - RS-232/IR	6
Figure 3: Connecting the FC-6 for Initial Configuration	8
Figure 4: Configuring a Remote Connection	10
Figure 5: Connecting the FC-6 Ethernet Gateway - RS-232/IR	11
Figure 6: Terminal Block Connections	12
Figure 7: Local Area Connection Properties Window	13
Figure 8: Internet Protocol Version 4 Properties Window	14
Figure 9: Internet Protocol Version 6 Properties Window	14
Figure 10: Internet Protocol Properties Window	15
Figure 11: General Info Page	18
Figure 12: Connected Clients Page	20
Figure 13: Device Settings Page	21
Figure 14: Communication Page	22
Figure 15: Serial Port Settings Page	23
Figure 16: IR Command Learner Page	24
Figure 17: Security Page	25
Figure 18: Security Confirmation Popup	25
Figure 19: Authentication Required Popup	26
Figure 20: Security Activated Page	26
Figure 21: Logs Page	27
Figure 22: About Us Page	28

1 Introduction

Welcome to Kramer Electronics! Since 1981, Kramer Electronics has been providing a world of unique, creative, and affordable solutions to the vast range of problems that confront video, audio, presentation, and broadcasting professionals on a daily basis. In recent years, we have redesigned and upgraded most of our line, making the best even better!

Our 1,000-plus different models now appear in 14 groups that are clearly defined by function: GROUP 1: Distribution Amplifiers; GROUP 2: Switchers and Routers; GROUP 3: Control Systems; GROUP 4: Format/Standards Converters; GROUP 5: Range Extenders and Repeaters; GROUP 6: Specialty AV Products; GROUP 7: Scan Converters and Scalers; GROUP 8: Cables and Connectors; GROUP 9: Room Connectivity; GROUP 10: Accessories and Rack Adapters; GROUP 11: Sierra Video Products; GROUP 12: Digital Signage; GROUP 13: Audio; and GROUP 14: Collaboration.

Congratulations on purchasing your Kramer **FC-6 Ethernet Gateway - RS-232/IR** that is ideal for:

- Remote IP control of RS-232 and IR controlled devices
- K-Touch multi-clients IP room control
- LAN-based expansion of K-Config control system

2 Getting Started

We recommend that you:

- Unpack the equipment carefully and save the original box and packaging materials for possible future shipment
- Review the contents of this user manual



Go to www.kramerav.com/downloads/FC-6 to check for up-to-date user manuals, application programs, and to check if firmware upgrades are available (where appropriate).

2.1 Achieving the Best Performance

To achieve the best performance:

- For optimum range and performance, use the recommended Kramer cables available at www.kramerav.com/product/FC-6
- Do not secure the cables in tight bundles or roll the slack into tight coils
- Avoid interference from neighbouring electrical appliances that may adversely influence signal quality
- Position your **FC-6** away from moisture, excessive sunlight and dust



This equipment is to be used only inside a building. It may only be connected to other equipment that is installed inside a building.

2.2 Safety Instructions



Caution: There are no operator serviceable parts inside the unit

Warning: Use only the Kramer Electronics power supply that is provided with the unit

Warning: Disconnect the power and unplug the unit from the wall before installing

2.3 Recycling Kramer Products

The Waste Electrical and Electronic Equipment (WEEE) Directive 2002/96/EC aims to reduce the amount of WEEE sent for disposal to landfill or incineration by requiring it to be collected and recycled. To comply with the WEEE Directive, Kramer Electronics has made arrangements with the European Advanced Recycling Network (EARN) and will cover any costs of treatment, recycling and recovery of waste Kramer Electronics branded equipment on arrival at the EARN facility. For details of Kramer's recycling arrangements in your particular country go to our recycling pages at www.kramerav.com/support/recycling/.

3 Overview

The **FC-6** is an RS-232/IR multi-function control gateway, capable of plug and play deployment over a customer Ethernet LAN for remote bidirectional RS-232 and IR emitter control of customer devices. Multiple control clients can be IP-connected to the **FC-6** control gateway for concurrent control of two RS-232 or four IR controllable devices, such as AV scalers, video displays, audio amplifiers, and DVD players.

This Ethernet to serial/IR gateway bridges the gap between Ethernet infrastructures and serial or IR communication devices by offering bidirectional Ethernet to serial and IR conversion. All setup and maintenance of the devices is done from built-in Web pages that are accessible using any common Web browser.

The **FC-6** features:

- Dual-Function I/O Ports - Remote IP-Based control of any device connected to the control gateway dual-function I/O ports, with selectable port configuration to bidirectional RS-232 or IR control.
- Multiple IP Connected Clients - Remotely connected over customer Ethernet network that concurrently controls any devices connected to control gateway I/O ports.
- Easy & Reliable Installation:
 - Resilient powering with USB and optional PSU (not included).
 - Compact, designed for piggy-back installation, such as behind a TV or display with the ability to draw power over USB.
- Remote Management - Built-in web UI for remote browser-based management and support, by multiple IP-clients over existing LAN. Easy firmware upgrades, either remotely via existing LAN, or locally via device USB port.
- Size - Pico TOOLS™ - Mount 4 units side-by-side in a 1U rack space with the optional RK-4PT rack adapter.

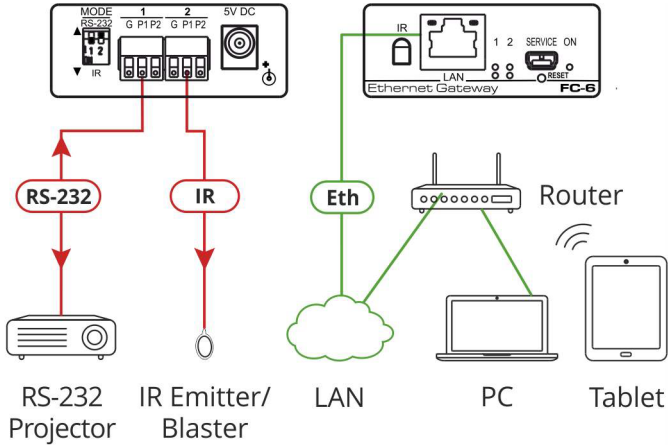

Figure 1: FC-6 Controlled Devices from Remote IP-based Clients

For example, using Kramer **K-Touch** control software you can design advanced room-control and automation systems that can be operated from iOS or Android touch devices. **K-Touch** can be used to perform device discovery over the network as the **FC-6** is set to IP 192.168.1.39.

You can use the Kramer **LAN Configurator** software to discover devices that are attached to the network, including the **FC-6**.

4 Defining the FC-6 Ethernet Gateway - RS-232/IR

This section defines the **FC-6**.

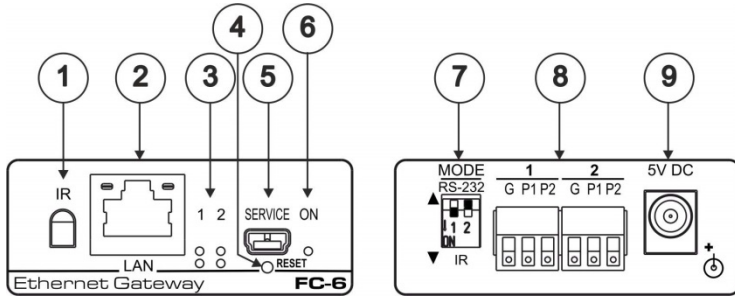

Figure 2: FC-6 Ethernet Gateway - RS-232/IR

#	Feature	Function
1	IR Sensor	Sensor for IR learning
2	LAN RJ-45 Connector	Connect to an IP client PC or other controller directly or via a LAN (see Section 6.1)
3	Port 1 and 2 white (upper) and blue LEDs	Show the transmission status of port 1 and port 2: When set as RS-232, the white LED indicates Tx and blue LED indicates Rx When set as IR, the white LED indicates IR _{P1} Tx and blue LED IR _{P2} indicates Tx
4	RESET Button	Press and hold while cycling the device power to reset to factory default parameters, (see Section 10)
5	SERVICE Mini USB Connector	Connects to a PC to supply power to the device or perform a local firmware upgrade
6	ON LED	Lights green when the unit is on
7	MODE DIP-switches (Port 1 and Port 2)	Switch up for RS-232, switch down for IR (the default setting is port 1 RS-232 (up) and port 2 IR (down))
8	Port 1 and 2 I/O 3-pin Terminal Block	Each terminal block connects one bidirectional RS-232 port or two IR outputs
9	5V DC Connector	Connect to the optional 5V DC power supply, center pin positive. Not needed when the device is supplied power by the USB connection

FC-6 Function Table

Port IO Function	Terminal Block Connections			IO Port Default	TCP Default Port [P1/P2]	Blue Activity LED Pair	Comment
	G	P1	P2				
RS-232	Ground	Rx	Tx	9600,8,N,1	5001/2	Flashes when port is transmitting & receiving data	Other serial configurations via Web, including RS-485 for Port 3
IR	Ground	IR1	IR2		5000	ON when ports are transmitting IR data	

Key:

P1 / P2 – Port 1 / Port 2

Tx – Transmit, Rx– Receive

9600, 8, N, 1 – 9600 baud, 8-bits, no parity, 1 stop bit

IR₁ / IR₂ – IR Port 1 / IR Port 2

5 Performing Initial Configuration

This chapter provides an overview of the initial configuration of the **FC-6** comprises:

- Configuring the **FC-6** (see [Section 5.1](#))
- Configuring an Ethernet connection on the PC (see [Section 5.2](#))

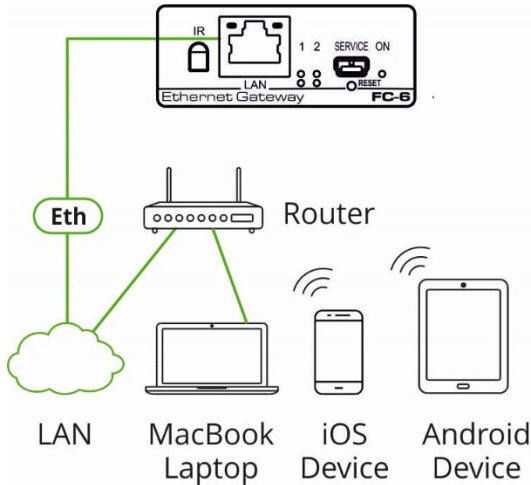

Figure 3: Connecting the FC-6 for Initial Configuration

5.1 Configuring the FC-6 Ethernet Gateway - RS-232/IR

Note: The FC-6 arrives with the default IP 192.168.1.39. To connect the **FC-6** on first installation, you must identify the IP address that was automatically assigned to the **FC-6**. To discover the IP address of **FC-6**, use **K-LAN Configurator**, available for download from our website at www.kramerav.com.

To browse the FC-6 Web UI on taking the device out of the box (using the default settings), use the default host name, (see [Section 10](#)).

Use the default host name: **FC-6-xxxx**, where xxxx are the last four digits of the serial number of the device.

To configure the FC-6:

1. Connect the Ethernet port on the rear panel of **FC-6** to a PC, either directly or via a LAN, (see [Section 6.1](#)).
2. Using a Web browser and the relevant IP address, browse the General Info home page (see [Figure 11](#)).
3. Click on **Device Settings** to browse to the Device Settings page, (see [Figure 13](#)).
4. Enter the time and date manually, or enter the Time server address for automatic time and date synchronization.
5. Click **Save Changes**.
6. Click on **Communication** to browse to the Communication page, (see [Figure 14](#)).
7. Enter the IP address, mask and gateway for static IP addressing and Click **Set**. We suggest a meaningful host name.
Note: If you have changed the IP address from the default setting, you must reload the General Info home page again using the new IP address.
8. Click on **Serial Ports Settings** to browse to the Serial Port Settings page, (see [Figure 15](#)).
9. Associate the required serial ports with their corresponding TCP/UDP settings.
10. For each associated serial port, enter the serial port configuration parameters using the drop-down lists under Serial Configuration.
11. Click **Save Changes**.
12. If required, click on **Security** to browse to the Security page.
13. Click **ON** to activate security.
The user name and password credentials popup appears.

14. Enter the required user name and password. (The default user name is **Admin** and the password is **Admin**).

5.2 Setting Up an Ethernet Connection on the PC

If the control application can directly connect to the Ethernet driver, select the host IP address and port number according to your **FC-6** configuration, as illustrated in [Figure 4](#).

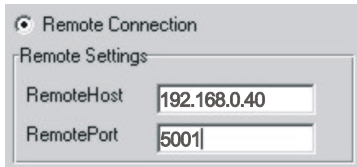

Remote Connection

Remote Settings

RemoteHost 192.168.0.40

RemotePort 5001

Figure 4: Configuring a Remote Connection

6 Connecting the FC-6



Always switch off the power to each device before connecting it to your **FC-6**. After connecting your **FC-6**, connect its power and then switch on the power to each device.

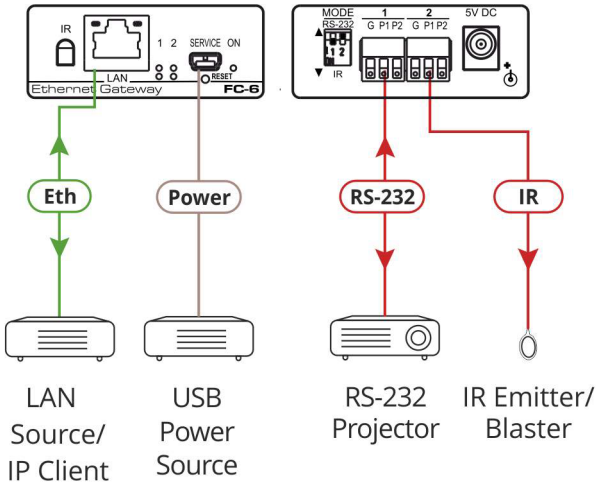

Figure 5: Connecting the FC-6 Ethernet Gateway - RS-232/IR

To connect the FC-6 as illustrated in the example in [Figure 5](#):

1. Connect the device to a LAN or PC via the RJ-45 Ethernet connector.
2. Set DIP-switch 1 up to select RS-232.
Connect an RS-232-controlled device, (for example, a projector) to terminal block 1, according to the connections shown in [Figure 6](#).
3. Set DIP-switch 2 down to select IR.
Connect an IR device (for example, an emitter/blaster) to terminal block 2, P1 (or P2), according to the connections shown in [Figure 6](#).

Port IO Function	Terminal Block Connections		
	G	P1	P2
RS-232	Ground	Rx	Tx
IR	Ground	IR1	IR2

Figure 6: Terminal Block Connections

4. If the **FC-6** does not receive power from a USB power connection, connect the device to the power supply and connect the power adapter to the mains electricity (not shown in [Figure 5](#)).

Note: You can connect up to four IR devices or up to two RS-232 devices if both ports are used for each setting.

6.1 Connecting via Ethernet

You can connect to the **FC-6** via Ethernet using either of the following methods:

- Directly to the PC using a crossover cable (see [Section 6.1.1](#))
- Via a network hub, switch, or router, using a straight-through cable (see [Section 6.1.2](#))

Note: If you want to connect via a router and your IT system is based on IPv6, speak to your IT department for specific installation instructions.

6.1.1 Connecting the Ethernet Port Directly to a PC

You can connect the Ethernet port of the **FC-6** directly to the Ethernet port on your PC using a crossover cable with RJ-45 connectors.



This type of connection is recommended for identifying the **FC-6** with the factory configured default IP address.

After connecting to the Ethernet port, configure your PC as follows:

1. Click **Start > Control Panel > Network and Sharing Center**.
2. Click **Change Adapter Settings**.
3. Highlight the network adapter you want to use to connect to the device and click **Change settings of this connection**.

The Local Area Connection Properties window for the selected network adapter appears as shown in [Figure 7](#).

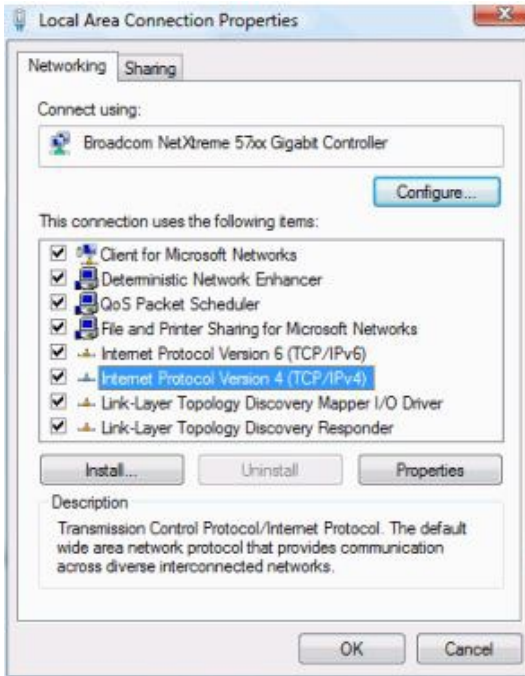

Figure 7: Local Area Connection Properties Window

4. Highlight **Internet Protocol Version 4 (TCP/IPv4)** and click **Properties**.

The Internet Protocol Properties window relevant to your IT system appears as shown in [Figure 8](#) or [Figure 9](#).

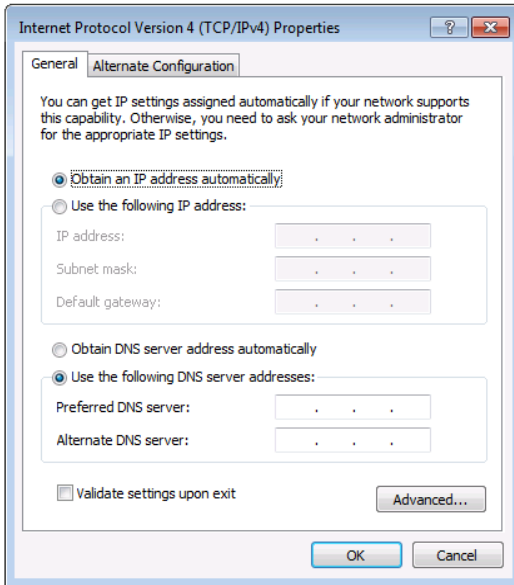

Figure 8: Internet Protocol Version 4 Properties Window

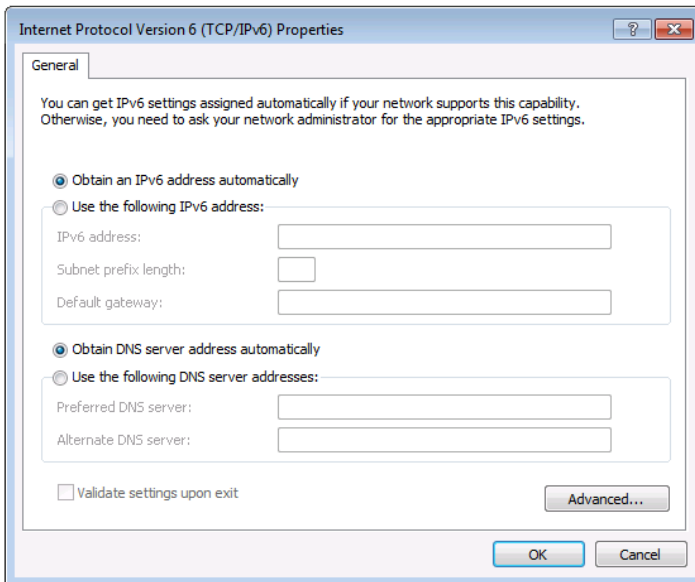

Figure 9: Internet Protocol Version 6 Properties Window

5. Select **Use the following IP Address** for static IP addressing and fill in the details as shown in [Figure 10](#).

For TCP/IPv4 you can use any IP address in the range 192.168.1.1 to 192.168.1.255 (excluding 192.168.1.39) that is provided by your IT department.

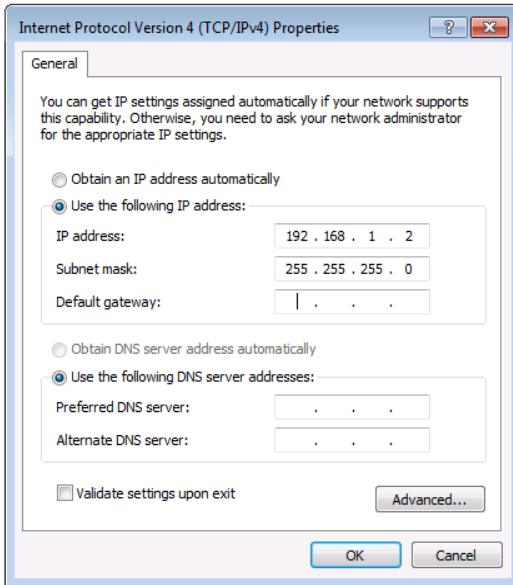

Figure 10: Internet Protocol Properties Window

6. Click **OK**.
7. Click **Close**.

6.1.2 Connecting the Ethernet Port via a Network Hub or Switch

You can connect the Ethernet port of the **FC-6** to the Ethernet port on a network hub or switch using a straight-through cable with RJ-45 connectors.

6.1.3 Connecting to the FC-6 via RS-232 or IR

To connect to the FC-6 via RS-232:

- Connect the RS-232, 3-pin, terminal block connectors on the rear panel of the **FC-6** using 3-wire cable (pin TX to pin 2, RX to pin 3, and G to pin 5) to the RS-232 9-pin D-sub port on the devices to be controlled

To connect to the FC-6 via IR:

- Connect an IR blaster to one of the IR Outputs and place it within 4m to 8m (13 to 26ft) and in line-of-sight of the device to be controlled

—OR—

- Connect an IR emitter cable to one of the IR Outputs and stick the emitter to the IR sensor on the device to be controlled

7 Remote Operation via the Web UI

The embedded Web UI can be used to remotely operate the **FC-6** using a Web browser and an Ethernet connection.

Before attempting to connect:

- Perform the initial configuration in [Section 5.1](#) and connecting via Ethernet in [Section 6.1](#)
- Ensure that your browser is supported (see [Section 9](#))

7.1 Browsing the Web UI

To browse the Web UI pages:

1. Open your Internet browser. Type the IP address of the device (see [Section 5.1](#)) in the Address bar of your browser.



The Loading page appears followed shortly by the General Info page shown in [Figure 11](#).

The General Info page displays the following:

- Model Name
- Firmware version
- Device serial number
- Web UI version

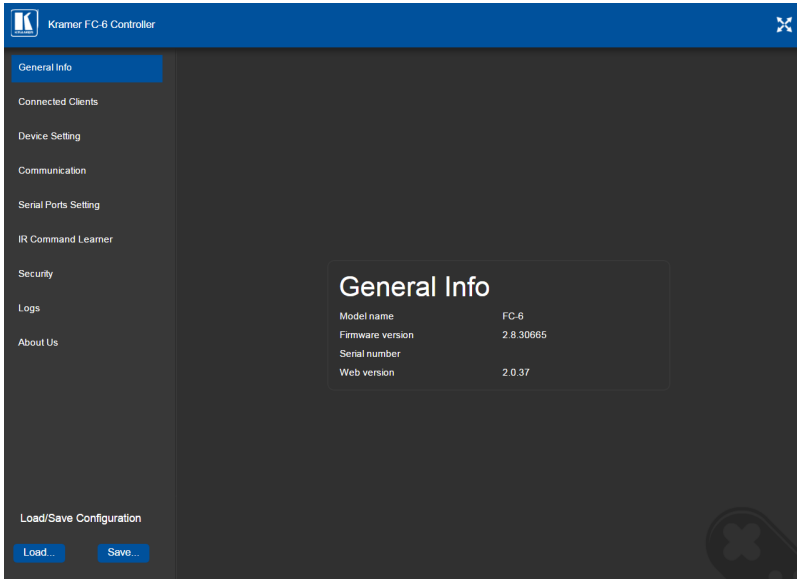

Figure 11: General Info Page

Loading and Saving Configurations

Loading and saving configurations is used for duplicating multiple device definitions for easy system configuration. The configurations are loaded and saved to a local PC. Load and save is performed using the buttons at the bottom left-hand side of the screen for all pages displayed.

To load a configuration:

1. Click **Load**.
The Explorer window opens.
2. Browse to the required file.
3. Select the required file and click **Open**.
The device is configured according to the saved preset.

To save the current configuration:

1. Configure the device as required.
2. Click **Save**.
The Save File window opens.
3. Browse to the required location to save the file.
4. Enter the required name for the saved preset.
5. Click **OK**.
The current configuration is saved.

Note: When using Chrome, the file is automatically saved in the Downloads folder.

The following parameters are saved to the configuration file:

UI Page	Parameter
Device Settings (Figure 7.3)	Model Name Time Zone Daylight Savings Time mode Use Time Server mode Time Server Address Sync Every Day time
Communication (Figure 7.4)	UDP Port TCP Port
Serial Port Setting (Figure7.5)	Serial Port Protocol IP Port TCP Keep Alive Parity Data Bits Baud Rate Stop Bits Send Replies to New Client by Default

7.2 Displaying Connected Clients

The Connected Clients page ([Figure 12](#)) allows you to view the following details of any client devices connected via Ethernet to the **FC-6**:

- IP address
- Its connection port

- Method of connection
- Whether or not Send Replies is enabled for the port

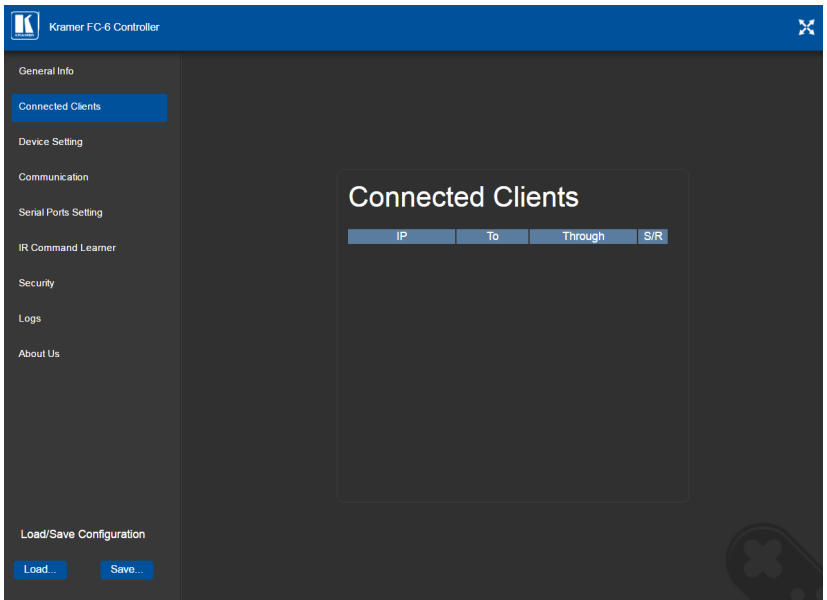

Figure 12: Connected Clients Page

7.3 Setting Device Name and Time Functions

The Device Settings page ([Figure 13](#)) allows you to view the model name and time server status. You can also modify the following fields:

- Device name
- Device time, date, and time zone
- Use a timeserver to set the time and date automatically using a (if the device is connected to the Internet), including the Time Zone and daylight savings time

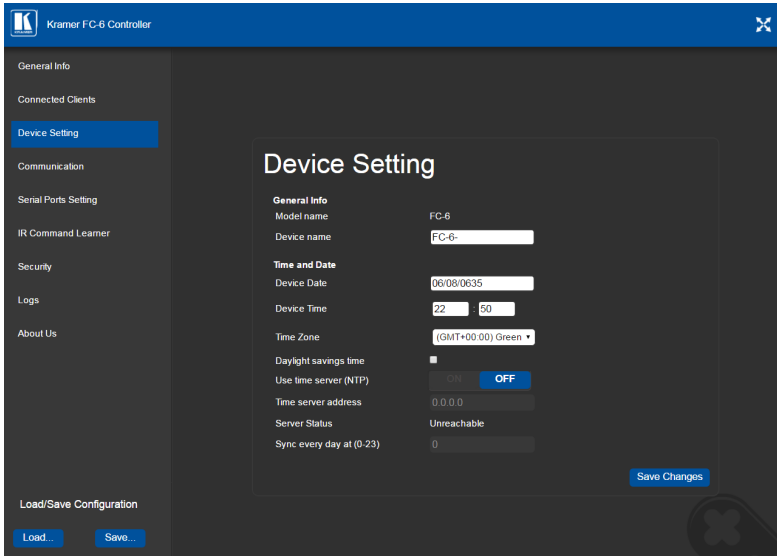

Figure 13: Device Settings Page

The **FC-6** has a built-in clock that can synchronize with a Time Server if required.

To enable Time Server synchronization:

1. Browse to the Device Settings page by clicking Device Settings.
The Device Settings page is displayed as shown in [Figure 13](#).
2. Click the Use Time Server **ON** button.
3. Enter the IP address of the Time Server.
4. Enter the time of day **FC-6** synchronizes with the Time Server.
5. Click **Save Changes**.

7.4 Setting Communication Parameters

The communication page allows you to:

- Turn DHCP for the device on and off
- Edit the IP settings for static IP addressing

Note: The default IP address setting for the device is IP 192.168.1.39.

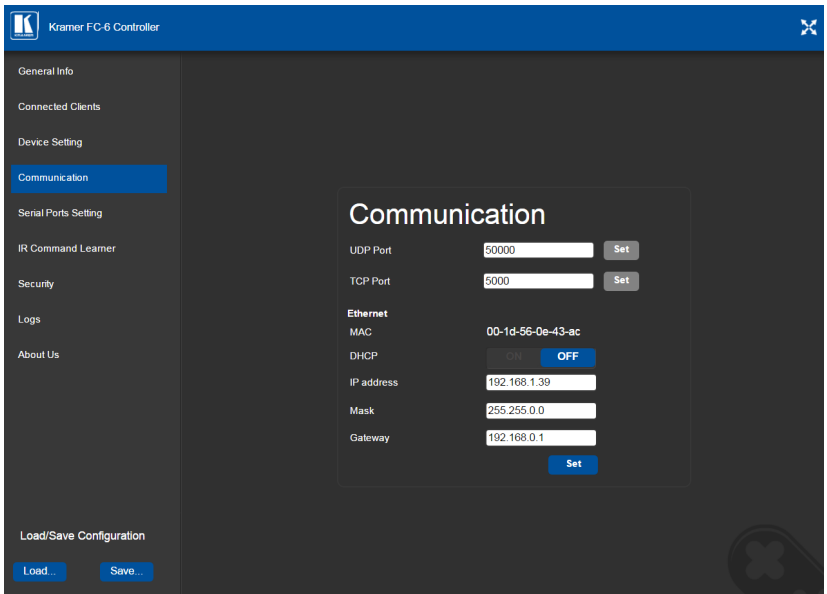

Figure 14: Communication Page

After modifying any of the IP settings, click **Set** to save the changes.

7.5 Setting Serial Port Parameters

The Serial Port Settings page allows you to:

- Set the following Ethernet parameters for each Ethernet port:
 - Select TCP or UDP
 - IP port label
 - TCP keep-alive time
 - TCP keep alive time – 0-3600sec (default 60sec) internal time, after which detected idle connection is disconnected
- Set the following serial parameters for each serial port:
 - Parity
 - Data bits
 - Baud rate
 - Stop bits
- Select whether or not to send replies on the port to the new client

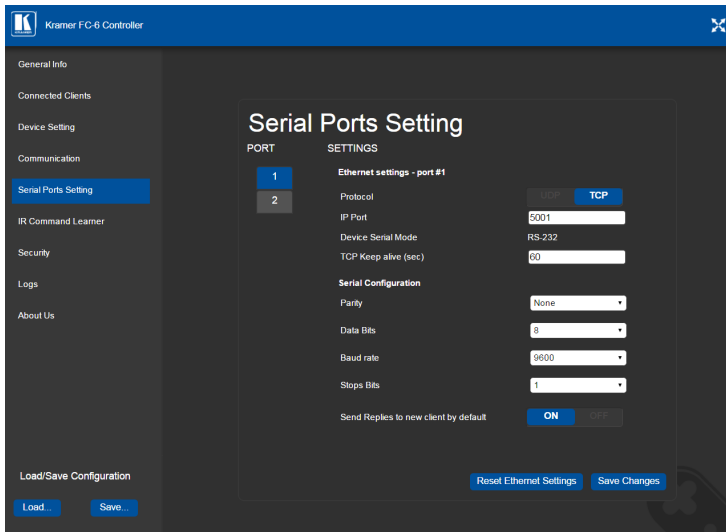

Figure 15: Serial Port Settings Page

7.6 Configuring IR Command Learning

The IR Command Learner page allows you to teach the **FC-6** IR commands. These can be saved for later use.

Note: While learning is in progress, the four IR Out LEDs light and the **FC-6** is not available for normal operation.

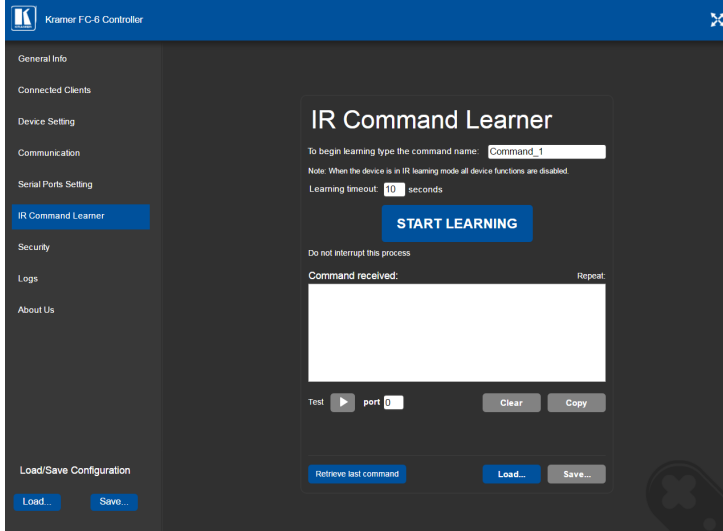

Figure 16: IR Command Learner Page

Feature	Function
Command Name Field	Enter the required name for the command
Learning Timeout	Set the time to elapse before the learning mode is exited if no command is received
Start Learning Button	Press to start the learning process. Note: While learning is in progress, the four IR Out LEDs light and the FC-6 is not available for normal operation.
Command Received Window	Displays the command string received during the process. This command can be copied/pasted to another application
Test Button and Port Selection Spinner	Select the port on which to test the learned command and press the Test button to start the test
Retrieve Last Command Button	Press to retrieve that last command learned
Clear/Copy Buttons	Press to clear or copy the command received
Load/Save Buttons	Press Load to retrieve a previously saved command. Press Save to save the current command

7.7 Activating Security

The Security page allows you to turn logon authentication on or off.

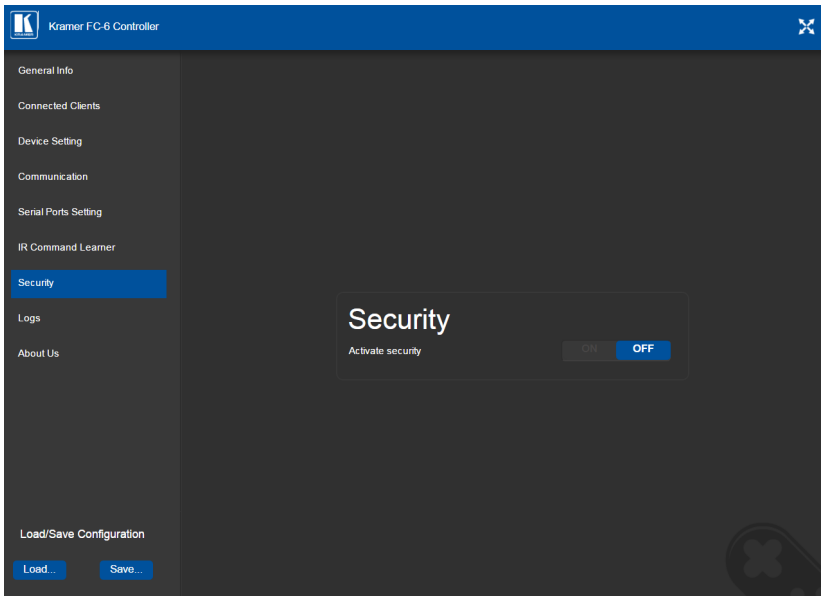

Figure 17: Security Page

When security is on, access to the Web pages is granted only on submission of a valid user and password. The default user ID is **Admin** and the password is **Admin**.

To activate Web page security:

1. On the Security page, click **ON**.

The confirmation popup is displayed as shown in [Figure 18](#).

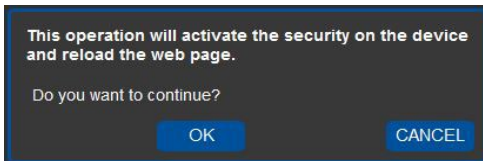

Figure 18: Security Confirmation Popup

2. Click **OK**.

The Authentication Required popup is displayed as shown in [Figure 19](#).

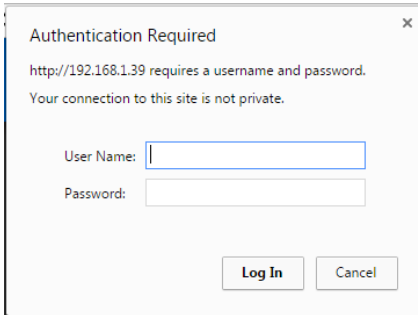

Figure 19: Authentication Required Pop-up

3. Enter the default username and password.
4. Click **OK**.
5. Wait until the Web UI has reloaded. Click the Security tab.
The page show in [Figure 20](#) is displayed.

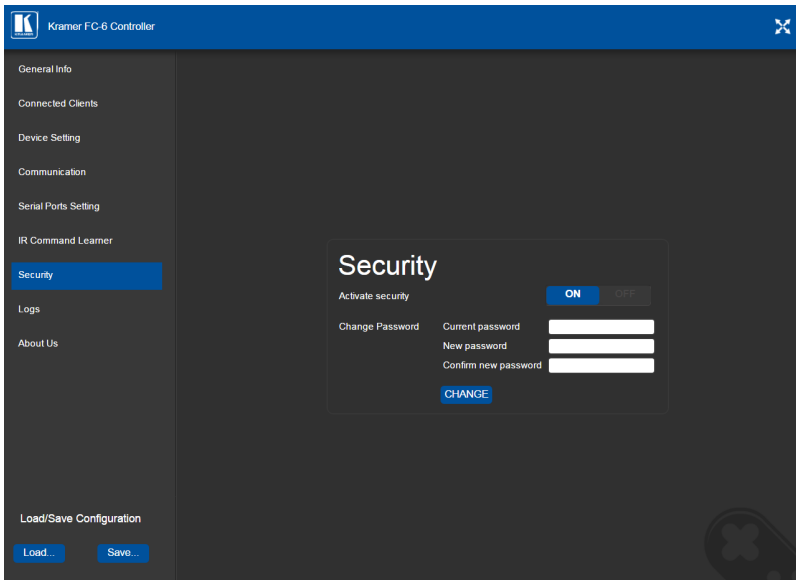

Figure 20: Security Activated Page

6. If required, click OFF to turn security off, or change the password and click Change.

7.8 Using the Logs Page

The Logs page allows you to:

- View current logs
- Configure the logs
- Filter the logs

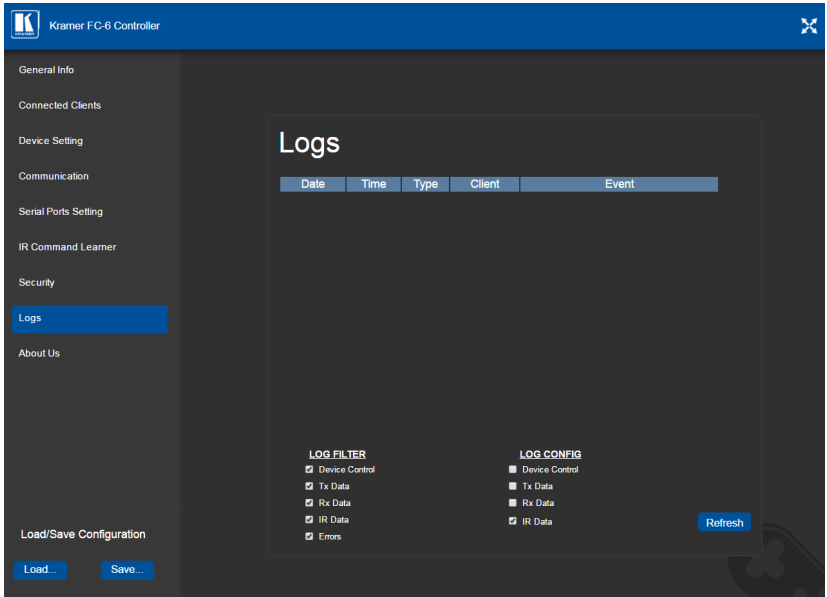

Figure 21: Logs Page

The display may not update automatically. Click **Refresh** to update the display.

Use the Log Filter check-boxes to select which events to display from the log. Use the Log Config check-boxes to select which events are recorded.

7.9 Kramer Information

The About Us page displays the Web page version and the Kramer company details.

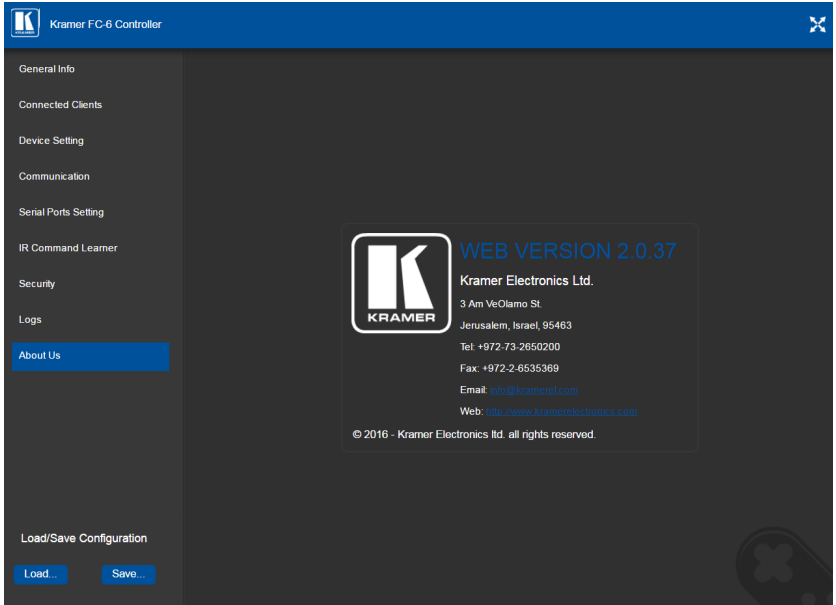

Figure 22: About Us Page

8 Using FC-6 Operations

This section explains how to use IR learning, reset the device and upgrade device firmware.

8.1 IR Learning

At the start and end of learning a message is sent to all attached clients.

To perform IR learning, the IR remote control must be approximately five to seven centimeters (2" and 2.7") from the **FC-6** front panel.

Note: While learning is in progress, the **FC-6** is not available for normal operation.

To teach the FC-6 an IR command:

1. Put the **FC-6** in IR Learning mode either by sending the Protocol 3000 command, (see [Section 11.2](#)) or by using the Web pages, (see [Section 7.6](#)). The device is no longer in normal operation, and the **FC-6** sends an IR Learning start message to all connected clients.
2. Using the IR remote control, send the required command to the **FC-6**. The **FC-6** processes the IR detected signal and generates the signal-associated pronto code to be used by the driver. When using the Web page for IR learning, the **FC-6** also displays the learned command code on screen. (This command can be copied/pasted to other applications, for example, control software when creating a driver.) The **FC-6** then sends the IR Learning stop message to all connected clients to indicate return to normal operation.
3. Optional—Test the command if using the IR Learning Web page. Test results are displayed on screen.
4. Save the learned command.

8.2 Resetting to the Factory Default Settings

To reset the device to its factory default settings:

1. Turn off the power to the device.
2. Press and hold the Reset button on the front panel.
3. Turn on the power to the device while holding down the Reset button for a few seconds.
4. Release the button.

The device is reset to the factory default settings.

8.3 Upgrading the Firmware

For instructions on upgrading the firmware see the "*Kramer K-Upload User Manual*".

9 Technical Specifications

Ports	2 RS-232 bidirectional serial or 4 IR (selectable)	On 3-pin terminal blocks
	1 LAN	On an RJ-45 connector
	1 IR sensor	For IR learning
	1 mini USB connector	For programming
Serial	Serial port baud rates	1200, 2400, 4800, 9600, 19200, 38400, 57600, 15200bps
	RS-232 communication	Transparent up to 115200bps
IR	IR emitter cable range	80m (260ft)
	IR output frequencies	20kHz to 1.2MHz
	IR input frequencies	20kHz to 60kHz
Data and Connections	Maximum data handling of device	Up to 150kbps (summed on all ports, see Section 9.1)
	Maximum simultaneous IP-client connections	40
Power	Power consumption	5V DC, 300mA
Cooling	Convection ventilation	
Environmental Conditions	Operating temperature	0° to +40°C (32° to 104°F)
	Storage temperature	-40° to +70°C (-40° to 158°F)
	Humidity	10% to 90%, RHL non-condensing
Regulatory Compliance	Vibration	ISTA 1A in carton (International Safe Transit Association)
	Safety	CE
	Environmental	RoHs, WEEE
General	Enclosure type	Aluminum
	Net dimensions	6.22cm x 5.18cm x 2.44cm (2.45" x 2.0" x 1.0") W, D, H.
	Net weight	0.084kg (3.0ozs) approx.
	Shipping dimensions	15.7cm x 12cm x 8.7cm (6.2" x 4.7" x 3.4") W, D, H.
	Shipping weight	0.43kg (0.94lbs) approx.
Accessories	Included	3ft USB cable, bracket set
	Optional	5V DC power adapter, 19" rack adapter, IR and serial cables – see www.kramerav.com/product/FC-6
Specifications are subject to change without notice at www.kramerav.com		

9.1 Data Handling Performance

The **FC-6** is designed to support mainly AV-relevant RS-232 communication.

These devices must have overall data bandwidth limits high enough in most AV installations to support the required communication bandwidth.

In extremely demanding cases, we recommend that you take into account the bandwidth limitations.

The total sustained data bandwidth that each device can handle for all ports simultaneously is 150kbps.

9.2 Example Bandwidth Calculation

The **FC-6** has two serial ports. Each serial port can support up to:

- $150\text{kbps} / 2 = 75\text{kbps}$

If each protocol command is 100 bytes, (that is, 800 bits), you can safely send and receive a minimum of 96 commands per second on each serial port. This is shown using the following calculation:

$$(150\text{kbps} * 1024) / 800 \text{ bits} / 2 = 96$$

The same calculation applies to all devices. A similar calculation applies when fewer ports are used at the same time where a higher bandwidth per port can be achieved.

In critical applications requiring a lossless data transfer, we recommend that communication on all the other ports is stopped when making a long file transfer (for example, when performing a firmware upgrade via one of the serial ports).

10 Default Communication Parameters

RS-232	
Protocol 3000	
Baud Rate:	115200
Data Bits:	8
Stop Bits:	1
Parity:	None

Note: The FC-6 arrives with the default IP 192.168.1.39. After performing a factory reset, the DHCP and the IP address are set to the values shown below.

Ethernet	
DHCP:	Off
IP Address:	192.168.1.39
Host Name:	FC-6-xxxx where xxxx are the last four digits of the serial number of the device
Subnet Mask:	255.255.0.0
Gateway:	192.168.0.1
TCP Device Port	5000
TCP Serial Port 1:	5001
TCP Serial Port 2:	5002
UDP Device Port:	50000

Default Logon Authentication

Web Page Access	
User name:	Admin
Password:	Admin

11 Kramer Protocol 3000

The **FC-6** can be operated using the Kramer Protocol 3000 serial commands. The command framing varies according to how you interface with the **FC-6**. For example, a basic video input switching command that routes a layer 1 video signal to HDMI out 1 from HDMI input 2 (`ROUTE 1, 1, 2`), is entered as follows:

- Terminal communication software, such as Hercules:

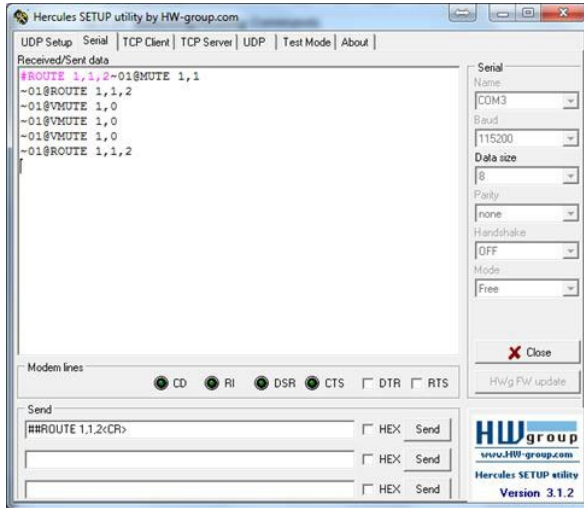

The framing of the command varies according to the terminal communication software.

- K-Touch Builder (Kramer software):

'Device Code (17)' PROPERTIES	
name	Device Code (17)
data	#ROUTE 1,1,2x0D

- K-Config (Kramer configuration software):



All the examples provided in this section are based on using the K-Config software.

You can enter commands directly using terminal communication software (e.g., Hercules) by connecting a PC to the serial or Ethernet port on the **FC-6**. To enter **CR** press the Enter key (**LF** is also sent but is ignored by the command parser).

Commands sent from various non-Kramer controllers (e.g., Crestron) may require special coding for some characters (such as, /x##). For more information, refer to your controller's documentation.

11.1 Kramer Protocol 3000 – Syntax

11.1.1 Host Message Format

Start	Address (optional)	Body	Delimiter
#	<i>Destination_id@</i>	Message	CR

11.1.1.1 Simple Command

Command string with only one command without addressing:

Start	Body	Delimiter
#	Command SP <i>Parameter_1,Parameter_2,...</i>	CR

11.1.1.2 Command String

Formal syntax with commands concatenation and addressing:

Start	Address	Body	Delimiter
#	<i>Destination_id@</i>	Command_1 <i>Parameter1_1,Parameter1_2,...</i> Command_2 <i>Parameter2_1,Parameter2_2,...</i> Command_3 <i>Parameter3_1,Parameter3_2,...</i> ...	CR

11.1.2 Device Message Format

Start	Address (optional)	Body	Delimiter
~	Sender_id@	Message	CR LF

11.1.2.1 Device Long Response

Echoing command:

Start	Address (optional)	Body	Delimiter
~	Sender_id@	Command SP [Param1 ,Param2 ...] result	CR LF

CR = Carriage return (ASCII 13 = 0x0D)

LF = Line feed (ASCII 10 = 0x0A)

SP = Space (ASCII 32 = 0x20)

11.1.3 Command Terms

Command

A sequence of ASCII letters ('A'-'Z', 'a'-'z' and '-').

Command and parameters must be separated by at least one space.

Parameters

A sequence of alphanumeric ASCII characters ('0'-'9','A'-'Z','a'-'z' and some special characters for specific commands). Parameters are separated by commas.

Message string

Every command entered as part of a message string begins with a **message starting character** and ends with a **message closing character**.

Note: A string can contain more than one command. Commands are separated by a pipe ('|') character.

Message starting character

'#' – For host command/query

'~' – For device response

Device address (Optional, for K-NET)

K-NET Device ID followed by '@'

Query sign

'?' follows some commands to define a query request.

Message closing character

CR – For host messages; carriage return (ASCII 13)

CRLF – For device messages; carriage return (ASCII 13) + line-feed (ASCII 10)

Command chain separator character

When a message string contains more than one command, a pipe ('|') character separates each command.

Spaces between parameters or command terms are ignored.

11.1.4 Entering Commands

You can directly enter all commands using a terminal with ASCII communications software, such as HyperTerminal, Hercules, etc. Connect the terminal to the serial or Ethernet port on the Kramer device. To enter **CR** press the Enter key. (**LF** is also sent but is ignored by command parser).

For commands sent from some non-Kramer controllers like Crestron, some characters require special coding (such as, /X##). Refer to the controller manual.

11.1.5 Command Forms

Some commands have short name syntax in addition to long name syntax to allow faster typing. The response is always in long syntax.

11.1.6 Chaining Commands

Multiple commands can be chained in the same string. Each command is delimited by a pipe character ("|"). When chaining commands, enter the **message starting character** and the **message closing character** only once, at the beginning of the string and at the end.

Commands in the string do not execute until the closing character is entered.

A separate response is sent for every command in the chain.

11.1.7 Maximum String Length

64 characters

11.2 Kramer Protocol 3000 – Command List

Command	Description
#	Protocol handshaking
BUILD-DATE	Read device build date
COM-ROUTE	Set/get tunneling port routing
COM-ROUTE-ADD	Add communication route tunnel connection
COM-ROUTE-REMOVE	Remove communication route tunnel connection
DEL	Deletes a file
DIR	List files
ETH-PORT	Sets protocol port
ETH-TUNNEL	Get parameters for open tunnels
FACTORY	Restart the machine with the default
FORMAT	Format the file system
FS-FREE	Print free file space
GET	Get file content
HELP	List of commands
LOGIN	Set/get protocol permission
LOGOUT	Demotes the terminal security level to minimum
MACH-NUM	Set device ID
MODEL	Read device model
NAME	Set/get device (DNS) name
NAME-RST	Reset device name to default
NET-DHCP	Set/get DHCP mode
NET-GATE	Set/get gateway IP
NET-IP	Set/get device IP address
NET-MAC	Get the MAC address
NET-MASK	Set/get the device subnet mask
PASS	Set/get the password for login level
PORT-LOCK	Set/get the port lock state
PORT-TYPE	Set/get the port type
PROT-VER	Get protocol version
RESET	Reset device
SECUR	Set/get current security state
SN	Get device serial number
TIME	Set/get the time
TIME-LOC	Set/get local time offset from UTC/GMT
TIME-SRV	Set/get time synchronization from server
UART	Set/get a port serial parameters
VERSION	Get firmware version number

11.3 Kramer Protocol 3000 – Detailed Commands

This section lists the detailed commands applicable to the **FC-6**.

11.3.1

Functions		Permission	Transparency
Set:	#	End User	Public
Get:	-	-	-
Description		Syntax	
Set:	Protocol handshaking	# <code>CR</code>	
Get:	-	-	
Response			
~ <code>nn</code> @ <code>SE</code> OK <code>CR LF</code>			
Parameters			
Response Triggers			
Notes			
Validates the Protocol 3000 connection and gets the machine number Step-in master products use this command to identify the availability of a device			
K-Config Example			
"##", 0x0D			

11.3.2 BUILD-DATE?

Functions		Permission	Transparency
Set:	-	-	-
Get:	BUILD-DATE?	End User	Public
Description		Syntax	
Set:	-	-	
Get:	Get device build date	#BUILD-DATE? <code>CR</code>	
Response			
~ <code>nn</code> @BUILD-DATE <code>SE</code> date <code>SE</code> time <code>CR LF</code>			
Parameters			
date – Format: YYYY/MM/DD where YYYY = Year, MM = Month, DD = Day time – Format: hh:mm:ss where hh = hours, mm = minutes, ss = seconds			
Response Triggers			
Notes			
K-Config Example			
"#BUILD-DATE?", 0x0D			

11.3.3 COM-ROUTE

Functions		Permission	Transparency
Set:	-	-	-
Get:	COM-ROUTE?	End User	Internal
Description		Syntax	
Set:	Set tunneling port routing	#COM-ROUTE ^[sp] <i>COM_Num,portType,ETHPort,ETH_rep_en,TCP_keep_alive_timing</i> ^[cr]	
Get:	Get tunneling port routing	#COM-ROUTE? ^[sp] <i>COM_Num</i> ^[cr]	
Response			
~ ^[nl] @COM-ROUTE ^[sp] <i>COM_Num,portType,ETHPort,ETH_rep_en,TCP_keep_alive_timing</i> ^[cr lf]			
Parameters			
<i>COM_Num</i> - machine dependent, * (get all route tunnels) <i>portType</i> - 1 (UDP), 2 (TCP) <i>ETHPort</i> - TCP/UDP port number <i>ETH_rep_en</i> - 0 (COM port does not send replies to new clients), 1 (COM port sends replies to new clients) <i>TCP_keep_alive_timing</i> - 0-3600 seconds - every x seconds the device sends an empty string to TCP client ("/0")			
Response Triggers			
Notes			
This command sets tunneling port routing. Every com port can send or receive data from the ETH port. All com ports can be configured to the same ETH port.			
K-Config Example			
Set COM1 as RS-232, port 1, Eth port 1, send replies, keep alive 30 seconds "#COM-ROUTE 1,1,1,1,30",0x0D			

11.3.4 COM-ROUTE-ADD

Functions		Permission	Transparency
Set:	COM-ROUTE-ADD	Administrator	Internal
Get:	-	-	-
Description		Syntax	
Set:	Add a communication route tunnel connection	#COM-ROUTE-ADD <input type="text" value="SP"/> <i>ComNum,PortType,EthPort,EthRepEn,Timeout</i> <input type="text" value="CR"/>	
Get:	-	-	
Response			
~ <input type="text" value="Hn"/> @COM-ROUTE-ADD <input type="text" value="SP"/> <i>ComNum,PortType,EthPort,EthRepEn,Timeout</i> <input type="text" value="CR LF"/>			
Parameters			
<p><i>COMNum</i> - machine dependent <i>portType</i> - 1 (UDP), 2 (TCP) <i>ETHPort</i> - TCP/UDP port number <i>ETHRepEn</i> - 0 (COM port does not send replies to new clients), 1 (COM port sends replies to new clients) <i>Timeout</i> - Keep alive timeout in seconds (1 to 3600)</p>			
Response Triggers			
Notes			
K-Config Example			
<p>Add COM1 port as TCP, port 1, Eth port 1, send replies, keep alive 30 seconds "#COM-ROUTE-ADD 1,1,1,1,30",0x0D</p>			

11.3.5 COM-ROUTE-REMOVE

Functions		Permission	Transparency
Set:	COM-ROUTE-REMOVE	Administrator	Internal
Get:	-	-	-
Description		Syntax	
Set:	Remove a communication route tunnel connection	#COM-ROUTE-REMOVE <input type="text"/> <i>ComNum</i> <input type="text"/>	
Get:	-	-	
Response			
~ <input type="text"/> @COM-ROUTE-REMOVE <input type="text"/> <i>ComNum</i> <input type="text"/>			
Parameters			
<i>ComNum</i> – machine dependent			
Response Triggers			
Notes			
K-Config Example			
Remove comm port 1. "#COM-ROUTE-REMOVE 1",0x0D			

11.3.6 DEL

Functions		Permission	Transparency
Set:	DEL	Administrator	Public
Get:	-	-	-
Description		Syntax	
Set:	Delete file	#DEL <input type="text"/> <i>file_name</i> <input type="text"/>	
Get:			
Response			
~ <input type="text"/> @DEL <input type="text"/> <i>file_name</i> <input type="text"/>			
Parameters			
<i>file_name</i> - name of file to delete (file names are case-sensitive)			
Response Triggers			
K-Config Example			
Delete a file named "test". "DEL test",0x0D			

11.3.7 DIR

Functions		Permission	Transparency
Set:	DIR	Administrator	Public
Get:	-	-	-
Description		Syntax	
Set:	List files in device	#DIR	
Get:	-	-	
Response			
Multi-line: ~nn@DIR file_name file_size bytes, ID: file_id free_size bytes.			
Parameters			
file_name - name of file file_size - file size in bytes. A file can take more space on device memory file_id - internal ID for file in file system free_size - free space in bytes in device file system			
Response Triggers			
K-Config Example			
"DIR", 0x0D			

11.3.8 ETH-PORT

Functions		Permission	Transparency
Set:	ETH-PORT	Administrator	Public
Get:	ETH-PORT?	End User	Public
Description		Syntax	
Set:	Set Ethernet port protocol	#ETH-PORT portType, ETHPort	
Get:	Get Ethernet port protocol	#ETH-PORT? portType	
Response			
~nn@ETH-PORT portType, ETHPort			
Parameters			
portType - 1 (UDP), 2 (TCP) ETHPort - TCP/UDP port number			
Response Triggers			
K-Config Example			
Set ETH port 1 to UDP. "ETH-PORT 2, 1", 0x0D			

11.3.9 ETH-TUNNEL

Functions		Permission	Transparency
Set:	-	-	-
Get:	ETH-TUNNEL?	Administrator	Internal
Description		Syntax	
Set:			
Get:	Get parameters for open tunnels	#ETH-TUNNEL? <input type="checkbox"/> TunnelId <input type="checkbox"/>	
Response			
~ <input type="checkbox"/> @ETH-TUNNEL <input type="checkbox"/>			
<i>TunnelId,ComNum,PortType,EthPort,EthIp,RemotPort,EthRepEn,Wired</i> <input type="checkbox"/>			
Parameters			
<i>TunnelId</i> – tunnel ID number: 1-64 (depends on number of tunnel connections), * (all tunnel connections)			
<i>ComNum</i> – UART number			
<i>portType</i> – 1 (UDP), 2 (TCP)			
<i>ETHPort</i> – TCP/UDP port number			
<i>EthIp</i> – client IP address			
<i>RemotPort</i> – remote port number			
<i>EthRepEn</i> – 0 (COM port does not send replies to new clients), 1 (COM port sends replies to new clients)			
<i>Wired</i> – 0 (non-wired connection), 1 (wired connection)			
Response Triggers			
Notes			
The response displays each tunnel in a separate line.			
K-Config Example			
`ETH-TUNNEL? 1",0x0D			

11.3.10 FACTORY

Functions		Permission	Transparency
Set:	FACTORY	End User	Public
Get:	-	-	-
Description		Syntax	
Set:	Reset device to factory default configuration	#FACTORYCR	
Get:	-	-	
Response			
~nn@FACTORYSFOKCR LF			
Parameters			
Response Triggers			
Notes			
This command deletes all user data from the device. The deletion can take some time. Your device may require powering off and powering on for the changes to take effect.			
K-Config Example			
"#FACTORY", 0x0D			

11.3.11 FORMAT

Functions		Permission	Transparency
Set:	FORMAT	Administrator	Public
Get:	-	-	-
Description		Syntax	
Set:	Format file system	#FORMATCR	
Get:	-	-	
Response			
~nn@FORMATSFOKCR LF			
Parameters			
Response Triggers			
Notes			
Response could take several seconds until formatting completes			
K-Config Example			
"#FORMAT", 0x0D			

11.3.12 FS-FREE

Functions		Permission	Transparency
Set:	-	-	-
Get:	FS-FREE?	Administrator	Public
Description		Syntax	
Set:	-	-	
Get:	Get file system free space	#FS-FREE? <code>[CR]</code>	
Response			
~ <code>[nn]</code> @FS_FREE? <code>[SP]</code> free_size <code>[CR LF]</code>			
Parameters			
<i>free_size</i> - free size in device file system in bytes			
Response Triggers			
K-Config Example			
"#FS-FREE?",0x0D			

11.3.13 GET

Functions		Permission	Transparency
Set:	-	-	-
Get:	GET	Administrator	Public
Description		Syntax	
Set:	-	-	
Get:	Get file	#GET <code>[SP]</code> file_name <code>[CR]</code>	
Response			
Multi-line: ~ <code>[nn]</code> @GET <code>[SP]</code> file_name,file_size <code>[SP]</code> READY <code>[CR LF]</code> contents ~ <code>[nn]</code> @GET <code>[SP]</code> file_name <code>[SP]</code> OK <code>[CR LF]</code>			
Parameters			
<i>file_name</i> - name of file to get contents <i>contents</i> - byte stream of file contents <i>file_size</i> - size of file (device sends it in response to give user a chance to get ready)			
Response Triggers			
K-Config Example			
Get a file named "test". "#GET test",0x0D			

11.3.14 HELP

Functions		Permission	Transparency
Set:	-	-	-
Get:	HELP	End User	Public
Description		Syntax	
Set:	-	-	
Get:	Get command list or help for specific command	1. #HELP <code>CR</code> 2. #HELP <code>SP</code> <code>COMMAND_NAME</code> <code>CR</code>	
Response			
1. Multi-line: ~ <code>nr</code> @Device available protocol 3000 commands: <code>CR LF</code> <code>command</code> , <code>SP</code> <code>command...</code> <code>CR LF</code>			
2. Multi-line: ~ <code>nr</code> @HELP <code>SP</code> <code>command</code> : <code>CR LF</code> <code>description</code> <code>CR LF</code> USAGE: <code>usage</code> <code>CR LF</code>			
Parameters			
<code>COMMAND_NAME</code> – name of a specific command			
Response Triggers			
Notes			
To get help for a specific command use: HELP <code>SP</code> <code>COMMAND_NAME</code> <code>CR LF</code>			
K-Config Example			
"#HELP", 0x0D			

11.3.15 LOGIN

Functions		Permission	Transparency
Set:	LOGIN	Not Secure	Public
Get:	LOGIN?	Not Secure	Public
Description		Syntax	
Set:	Set protocol permission	#LOGIN <code>[SF]</code> <i>login_level,password</i> <code>[CR LF]</code>	
Get:	Get current protocol permission level	#LOGIN? <code>[CR]</code>	
Response			
Set: ~ <code>[nn]</code> @LOGIN <code>[SF]</code> <i>login_level,password</i> <code>[SF]</code> <code>[OK]</code> <code>[CR LF]</code> or ~ <code>[nn]</code> @LOGIN <code>[SF]</code> ERR <code>[SF]</code> 004 <code>[CR LF]</code> (if bad password entered)			
Get: ~ <code>[nn]</code> @LOGIN <code>[SF]</code> <i>login_level</i> <code>[CR LF]</code>			
Parameters			
<i>login_level</i> – level of permissions required: User, Admin <i>password</i> – predefined password (by PASS command). Default password is an empty string			
Response Triggers			
Notes			
When the permission system is enabled, LOGIN enables running commands with the User or Administrator permission level When set, login must be performed upon each connection The permission system works only if security is enabled with the SECUR command. It is not mandatory to enable the permission system in order to use the device			
K-Config Example			
Set the protocol permission level to Admin (when the password defined in the PASS command is 33333): "#LOGIN Admin,33333",0x0D			

11.3.16 LOGOUT

Functions		Permission	Transparency
Set:	LOGOUT	Not Secure	Public
Get:	-	-	-
Description		Syntax	
Set:	Cancel current permission level	#LOGOUT <code>CR</code>	
Get:	-	-	
Response			
~ <code>nn</code> @LOGOUT <code>SP</code> OK <code>CR</code> LF			
Parameters			
Response Triggers			
Notes			
Logs out from User or Administrator permission levels			
K-Config Example			
"#LOGOUT", 0x0D			

11.3.17 MACH-NUM

Functions		Permission	Transparency
Set:	MACH-NUM	End User	Public
Get:		-	-
Description		Syntax	
Set:	Set machine number (device ID)	#MACH-NUM <code>SP</code> <i>machine_number</i> <code>CR</code>	
Get:	-	-	
Response			
~ <code>nn</code> @MACH-NUM <code>SP</code> <i>machine_number</i> <code>CR</code> LF			
Parameters			
<i>machine_number</i> – New machine number			
Response Triggers			
Notes			
The new machine number is only set after restarting the device.			
K-Config Example			
"#MACH-NUM 4", 0x0D			

11.3.18 MODEL

Functions		Permission	Transparency
Set:	-	-	-
Get:	MODEL?	End User	Public
Description		Syntax	
Set:	-	-	
Get:	Get device model	#MODEL? <code>CR</code>	
Response			
~ <code>nn</code> @MODEL <code>SF</code> <i>model_name</i> <code>CR LF</code>			
Parameters			
<i>model_name</i> – String of up to 19 printable ASCII chars			
Response Triggers			
Notes			
This command identifies equipment connected to Step-in master products and notifies of identity changes to the connected equipment. The Matrix saves this data in memory to answer REMOTE-INFO requests			
K-Config Example			
`#MODEL?`, 0x0D			

11.3.19 NAME

Functions		Permission	Transparency
Set:	NAME	Administrator	Public
Get:	NAME?	End User	Public
Description		Syntax	
Set:	Set machine (DNS) name	#NAME SP machine_name CR	
Get:	Get machine (DNS) name	#NAME? CR	
Response			
Set:	~nn@NAME SP machine_name CR LF		
Get:	~nn@NAME? SP machine_name CR LF		
Parameters			
<i>machine_name</i> - string of up to 15 alpha-numeric chars (can include hyphen, not at the beginning or end)			
Response Triggers			
Notes			
The machine name is not the same as the model name. The machine name is used to identify a specific machine or a network in use (with DNS feature on)			
K-Config Example			
Set machine name to FC-6-4321: "#NAME FC-6-4321", 0x0D			

11.3.20 NAME-RST

Functions		Permission	Transparency
Set:	NAME-RST	Administrator	Public
Get:	-	-	-
Description		Syntax	
Set:	Reset machine (DNS) name to factory default	#NAME-RST CR	
Get:	-	-	
Response			
~nn@NAME-RST SP OK CR LF			
Parameters			
Response Triggers			
Notes			
Factory default of machine (DNS) name is "KRAMER_" + 4 last digits of device serial number			
K-Config Example			
"#NAME-RST", 0x0D			

11.3.21 NET-DHCP

Functions		Permission	Transparency
Set:	NET-DHCP	Administrator	Public
Get:	NET-DHCP?	End User	Public
Description		Syntax	
Set:	Set DHCP mode	#NET-DHCP SP mode CR	
Get:	Get DHCP mode	#NET-DHCP? CR	
Response			
~nn@NET-DHCP SP mode CR LF			
Parameters			
mode – 0 (do not use DHCP. Use the IP address set by the factory or the NET-IP command), 1 (try to use DHCP. If unavailable, use the IP address set by the factory or the NET-IP command)			
Response Triggers			
Notes			
Connecting Ethernet to devices with DHCP may take more time in some networks To connect with a randomly assigned IP by DHCP, specify the device DNS name (if available) using the NAME command. You can also get an assigned IP by direct connection to USB or RS-232 protocol port if available Consult your network administrator for correct settings			
K-Config Example			
Enable DHCP mode, if available: `#NET-DHCP 1`, 0x0D			

11.3.22 NET-GATE

Functions		Permission	Transparency
Set:	NET-GATE	Administrator	Public
Get:	NET-GATE?	End User	Public
Description		Syntax	
Set:	Set gateway IP	#NET-GATE SP ip_address CR	
Get:	Get gateway IP	#NET-GATE? CR	
Response			
~nn@NET-GATE SP ip_address CR LF			
Parameters			
ip_address – gateway IP address, in the following format: xxx.xxx.xxx.xxx			
Response Triggers			
Notes			
A network gateway connects the device via another network, possibly over the Internet. Be careful of security problems. Consult your network administrator for correct settings.			
K-Config Example			
Set the gateway IP address to 192.168.0.1: `#NET-GATE 192.168.000.001`, 0x0D			

11.3.23 NET-IP

Functions		Permission	Transparency
Set:	NET-IP	Administrator	Public
Get:	NET-IP?	End User	Public
Description		Syntax	
Set:	Set IP address	#NET-IP <code>[SP]</code> <i>ip_address</i> <code>[CR]</code>	
Get:	Get IP address	#NET-IP? <code>[CR]</code>	
Response			
~ <code>[nn]</code> @NET-IP <code>[SP]</code> <i>ip_address</i> <code>[CR LF]</code>			
Parameters			
<i>ip_address</i> – IP address, in the following format: xxx.xxx.xxx.xxx			
Response Triggers			
Notes			
Consult your network administrator for correct settings			
K-Config Example			
Set the IP address to 192.168.1.39: "#NET-IP 192.168.001.039",0x0D			

11.3.24 NET-MAC

Functions		Permission	Transparency
Set:	-	-	-
Get:	NET-MAC?	End User	Public
Description		Syntax	
Set:	-	-	
Get:	Get MAC address	#NET-MAC? <code>[CR]</code>	
Response			
~ <code>[nn]</code> @NET-MAC <code>[SP]</code> <i>mac_address</i> <code>[CR LF]</code>			
Parameters			
<i>mac_address</i> – unique MAC address. Format: XX-XX-XX-XX-XX-XX where X is hex digit			
Response Triggers			
Notes			
K-Config Example			
"#NET-MAC?",0x0D			

11.3.25 NET-MASK

Functions		Permission	Transparency
Set:	NET-MASK	Administrator	Public
Get:	NET-MASK?	End User	Public
Description		Syntax	
Set:	Set subnet mask	#NET-MASK[SE]net_mask[CR]	
Get:	Get subnet mask	#NET-MASK?[SE]	
Response			
~nn@NET-MASK[SE]net_mask[CR LF]			
Parameters			
net_mask - format: xxx.xxx.xxx.xxx			
Response Triggers			
The subnet mask limits the Ethernet connection within the local network Consult your network administrator for correct settings			
Notes			
K-Config Example			
Set the subnet mask to 255.255.0.0: "#NET-MASK 255.255.000.000",0x0D			

11.3.26 PASS

Functions		Permission	Transparency
Set:	PASS	Administrator	Public
Get:	PASS?	Administrator	Public
Description		Syntax	
Set:	Set password for login level	#PASS[SE]login_level,password[CR]	
Get:	Get password for login level	#PASS?[SE]login_level[CR]	
Response			
~nn@PASS[SE]login_level,password[CR LF]			
Parameters			
login_level – level of login to set: User, Admin password – password for the login_level. Up to 15 printable ASCII chars.			
Response Triggers			
Notes			
The default password is an empty string			
K-Config Example			
Set the password for the Admin protocol permission level to 33333: "#PASS Admin,33333",0x0D			

11.3.27 PORT-LOCK

Functions		Permission	Transparency
Set:	PORT-LOCK	End User	Public
Get:	PORT-LOCK?	End User	Public
Description		Syntax	
Set:	Set the port lock	#PORT-LOCK _[SP] <i>PortNumber</i> , <i>LockState</i> _[CR]	
Get:	Get the port lock state	#PORT-LOCK? _[SP] <i>PortNumber</i> _[CR]	
Response			
~ _[n] @PORT-LOCK _[SP] <i>PortNumber</i> , <i>LockState</i> _[CR LF]			
Parameters			
<i>PortNumber</i> - port number (1-n) <i>LockState</i> - lock (1), unlock (0)			
Response Triggers			
Notes			
K-Config Example			
Lock port 3. `"#PORT-LOCK 3, 1",0x0D			

11.3.28 PORT-TYPE

Functions		Permission	Transparency
Set:	PORT-TYPE	End User	Public
Get:	PORT-TYPE?	End User	Public
Description		Syntax	
Set:	Change the port type	#PORT-TYPE _[SP] <i>PortNumber</i> , <i>PortType</i> , <i>PortName</i> , <i>485Term</i> _[CR]	
Get:	Get the port type	#PORT-TYPE? _[SP] <i>PortNumber</i> _[CR]	
Response			
~ _[n] @PORT-TYPE _[SP] <i>PortNumber</i> , <i>PortType</i> , <i>PortName</i> , <i>485Term</i> _[CR LF]			
Parameters			
<i>PortNumber</i> - Port number: 1-n <i>PortType</i> - 0 (RS-232), 4 (IR) <i>PortName</i> - A string describing the port type <i>485Term</i> - 485 termination state: 1 (enable), 0 (disable)			
Response Triggers			
Notes			
<i>485Term</i> is effective only when the port type is UART			
K-Config Example			
Change port 3 to relay and name it blinds: `"#PORT-TYPE 3,3,blinds",0x0D			

11.3.29 PROT-VER

Functions		Permission	Transparency
Set:	-	-	-
Get:	PROT-VER?	End User	Public
Description		Syntax	
Set:	-	-	
Get:	Get device protocol version	#PROT-VER? <code>CR</code>	
Response			
~ <code>nn</code> @PROT-VER? <code>SP</code> 3000:version <code>CR LF</code>			
Parameters			
version - XX.XX where X is a decimal digit			
Response Triggers			
Notes			
K-Config Example			
"#PROT-VER?", 0x0D			

11.3.30 RESET

Functions		Permission	Transparency
Set:	RESET	Administrator	Public
Get:	-	-	-
Description		Syntax	
Set:	Reset device	#RESET <code>CR</code>	
Get:	-	-	
Response			
~ <code>nn</code> @RESET? <code>SP</code> OK <code>CR LF</code>			
Parameters			
Response Triggers			
Notes			
To avoid locking the port due to a USB bug in Windows, disconnect USB connections immediately after running this command. If the port was locked, disconnect and reconnect the cable to reopen the port.			
K-Config Example			
"#RESET", 0x0D			

11.3.31 SECUR

Functions		Permission	Transparency
Set:	SECUR	Administrator	Public
Get:	SECUR?	Not Secure	Public
Description		Syntax	
Set:	Start/stop security	#SECUR ^{SP} security_mode ^{CR}	
Get:	Get current security state	#SECUR? ^{CR}	
Response			
~nn@SECUR ^{SP} security_mode ^{CR LF}			
Parameters			
security_mode – 1 (On / enable security), 0 (Off / disable security)			
Response Triggers			
Notes			
The permission system works only if security is enabled with the SECUR command			
K-Config Example			
Enable the permission system. `#SECUR 0",0x0D`			

11.3.32 SN

Functions		Permission	Transparency
Set:	-	-	-
Get:	SN?	End User	Public
Description		Syntax	
Set:	-	-	
Get:	Get device serial number	#SN? ^{CR}	
Response			
~nn@SN ^{SE} serial_number ^{CR LF}			
Parameters			
serial_number – 11 decimal digits, factory assigned			
Response Triggers			
Notes			
This device has a 14 digit serial number, only the last 11 digits are displayed			
K-Config Example			
`#SN?",0x0D`			

11.3.33 TIME

Functions		Permission	Transparency
Set:	TIME	Administrator	Public
Get:	TIME?	End User	Public
Description		Syntax	
Set:	Set device time and date	#TIME <code>SP</code> day_of_week,date,time <code>CR</code>	
Get:	Get device time and date	#TIME? <code>CR</code>	
Response			
~ <code>nn</code> @TIME <code>SP</code> day_of_week,date,time <code>CR LF</code>			
Parameters			
<i>day_of_week</i> - one of: SUN, MON, TUE, WED, THU, FRI, SAT <i>date</i> - format: DD-MM-YYYY <i>time</i> - format: hh:mm:ss			
Response Triggers			
Notes			
The year must be 4 digits The device does not validate the day of week from the date Time format - 24 hours Date format - Day, Month, Year			
K-Config Example			
Set the time to 09:45, Tuesday, 01-July-2015. "#TIME TUE,01-07-2015,09:45:00",0x0D			

11.3.34 TIME-LOC

Functions		Permission	Transparency
Set:	TIME-LOC	End User	Public
Get:	TIME-LOC?	End User	Public
Description		Syntax	
Set:	Set local time offset from UTC/GMT	#TIME-LOC[SE]UTC_off,DayLight[CR]	
Get:	Get local time offset from UTC/GMT	#TIME-LOC?[CR]	
Response			
~nn@TIME-LOC[SE]UTC_off,DayLight[CR LF]			
Parameters			
UTC_off - offset of device time from UTC/GMT (without daylight time correction)			
DayLight - 0 - no daylight saving time, 1 - daylight saving time			
Response Triggers			
Notes			
If the time server is configured, device time calculates by adding UTC_off to UTC time (that it got from the time server) + 1 hour if daylight savings time is in effect			
TIME command sets the device time without considering these settings			
K-Config Example			
Set the time offset to GMT +2, standard time			
`#TIME-LOC 2,0",0x0D			

11.3.35 TIME-SRV

Functions		Permission	Transparency
Set:	TIME-SRV	Administrator	Public
Get:	TIME-SRV?	End User	Public
Description		Syntax	
Set:	Set time server	#TIME-SRV SP <i>mode,time_server_IP,time_server_Sync_Hour</i> , CR	
Get:	Get time server	#TIME-SRV? CR	
Response			
~ nn @TIME-SRV SP <i>mode, time_server_IP, time_server_Sync_Hour,server_status</i> CR LF			
Parameters			
<i>mode</i> - 0 (OFF), 1 (ON) <i>time_server_IP</i> - time server IP address <i>time_server_Sync_Hour</i> - hour in day for time server sync <i>server_status</i> - ON/OFF			
Response Triggers			
Notes			
This command is needed for setting UDP timeout for the current client list			
K-Config Example			
Connect the device to a time server at a given IP address, activate and sync at 6AM "#TIME-SRV 1,xxx.xxx.xxx.xxx,06",0x0D			

11.3.36 UART

Functions		Permission	Transparency
Set:	UART	Administrator	Public
Get:	UART?	End User	Public
Description		Syntax	
Set:	Set com port configuration	#UART[SF] COM_Num,baud_rate,data_bit,parity,stop_bit[CR]	
Get:	Get com port configuration	#UART?[SF]COM_Num[CR]	
Response			
Set:	~[nn]@UART[SF]COM_Num,baud_rate,data_bit,parity,stop_bit[CR LF]		
Get:	-[nn]@UART[SF]COM_Num,baud_rate,data_bit,parity,stop_bit,serial1_type,485_term[CR LF]		
Parameters			
<p>COM_Num - 1-2 baud_rate - 9600 - 115200 data_bit - 7-8 parity - N (none), O (odd), E (even), M (mark), S (space) stop_bit - 1-2 serial1_type - 0 (RS-232) 485_term - 1/0 (optional - this exists exist only when serial1_type = 485)</p>			
Response Triggers			
Notes			
K-Config Example			
Configure RS-232 com port 1 to 9600 baud, 8 data bits, no parity, 1 stop bit "#UART 1,9600,8,N,1,0"0x0D			

11.3.37 VERSION

Functions		Permission	Transparency
Set:	-	-	-
Get:	VERSION?	End User	Public
Description		Syntax	
Set:	-	-	
Get:	Get firmware version number	#VERSION? CR	
Response			
~ nn @VERSION S <i>firmware_version</i> CR LF			
Parameters			
<i>firmware_version</i> – XX.XX.XXXX where the digit groups are: major.minor.build version			
Response Triggers			
Notes			
K-Config Example			
"#VERSION?", 0x0D			

LIMITED WARRANTY

The warranty obligations of Kramer Electronics for this product are limited to the terms set forth below:

What is Covered

This limited warranty covers defects in materials and workmanship in this product.

What is Not Covered

This limited warranty does not cover any damage, deterioration or malfunction resulting from any alteration, modification, improper or unreasonable use or maintenance, misuse, abuse, accident, neglect, exposure to excess moisture, fire, improper packing and shipping (such claims must be presented to the carrier), lightning, power surges, or other acts of nature. This limited warranty does not cover any damage, deterioration or malfunction resulting from the installation or removal of this product from any installation, any unauthorized tampering with this product, any repairs attempted by anyone unauthorized by Kramer Electronics to make such repairs, or any other cause which does not relate directly to a defect in materials and/or workmanship of this product. This limited warranty does not cover cartons, equipment enclosures, cables or accessories used in conjunction with this product.

Without limiting any other exclusion herein, Kramer Electronics does not warrant that the product covered hereby, including, without limitation, the technology and/or integrated circuit(s) included in the product, will not become obsolete or that such items are or will remain compatible with any other product or technology with which the product may be used.

How Long Does this Coverage Last

Seven years as of this printing; please check our Web site for the most current and accurate warranty information.

Who is Covered

Only the original purchaser of this product is covered under this limited warranty. This limited warranty is not transferable to subsequent purchasers or owners of this product.

What Kramer Electronics will do

Kramer Electronics will, at its sole option, provide one of the following three remedies to whatever extent it shall deem necessary to satisfy a proper claim under this limited warranty:

1. Elect to repair or facilitate the repair of any defective parts within a reasonable period of time, free of any charge for the necessary parts and labor to complete the repair and restore this product to its proper operating condition. Kramer Electronics will also pay the shipping costs necessary to return this product once the repair is complete.
2. Replace this product with a direct replacement or with a similar product deemed by Kramer Electronics to perform substantially the same function as the original product.
3. Issue a refund of the original purchase price less depreciation to be determined based on the age of the product at the time remedy is sought under this limited warranty.

What Kramer Electronics will not do Under This Limited Warranty

If this product is returned to Kramer Electronics or the authorized dealer from which it was purchased or any other party authorized to repair Kramer Electronics products, this product must be insured during shipment, with the insurance and shipping charges prepaid by you. If this product is returned uninsured, you assume all risks of loss or damage during shipment. Kramer Electronics will not be responsible for any costs related to the removal or re-installation of this product from or into any installation. Kramer Electronics will not be responsible for any costs related to any setting up this product, any adjustment of user controls or any programming required for a specific installation of this product.

How to Obtain a Remedy under this Limited Warranty

To obtain a remedy under this limited warranty, you must contact either the authorized Kramer Electronics reseller from whom you purchased this product or the Kramer Electronics office nearest you. For a list of authorized Kramer Electronics resellers and/or Kramer Electronics authorized service providers, please visit our web site at www.kramerelectronics.com or contact the Kramer Electronics office nearest you.

In order to pursue any remedy under this limited warranty, you must possess an original, dated receipt as proof of purchase from an authorized Kramer Electronics reseller. If this product is returned under this limited warranty, a return authorization number, obtained from Kramer Electronics, will be required. You may also be directed to an authorized reseller or a person authorized by Kramer Electronics to repair the product.

If it is decided that this product should be returned directly to Kramer Electronics, this product should be properly packed, preferably in the original carton, for shipping. Cartons not bearing a return authorization number will be refused.

Limitation on Liability

THE MAXIMUM LIABILITY OF KRAMER ELECTRONICS UNDER THIS LIMITED WARRANTY SHALL NOT EXCEED THE ACTUAL PURCHASE PRICE PAID FOR THE PRODUCT. TO THE MAXIMUM EXTENT PERMITTED BY LAW, KRAMER ELECTRONICS IS NOT RESPONSIBLE FOR DIRECT, SPECIAL, INCIDENTAL OR CONSEQUENTIAL DAMAGES RESULTING FROM ANY BREACH OF WARRANTY OR CONDITION, OR UNDER ANY OTHER LEGAL THEORY. Some countries, districts or states do not allow the exclusion or limitation of relief, special, incidental, consequential or indirect damages, or the limitation of liability to specified amounts, so the above limitations or exclusions may not apply to you.

Exclusive Remedy

TO THE MAXIMUM EXTENT PERMITTED BY LAW, THIS LIMITED WARRANTY AND THE REMEDIES SET FORTH ABOVE ARE EXCLUSIVE AND IN LIEU OF ALL OTHER WARRANTIES, REMEDIES AND CONDITIONS, WHETHER ORAL OR WRITTEN, EXPRESS OR IMPLIED. TO THE MAXIMUM EXTENT PERMITTED BY LAW, KRAMER ELECTRONICS SPECIFICALLY DISCLAIMS ANY AND ALL IMPLIED WARRANTIES, INCLUDING, WITHOUT LIMITATION, WARRANTIES OF MERCHANTABILITY AND FITNESS FOR A PARTICULAR PURPOSE. IF KRAMER ELECTRONICS CANNOT LAWFULLY DISCLAIM OR EXCLUDE IMPLIED WARRANTIES UNDER APPLICABLE LAW, THEN ALL IMPLIED WARRANTIES COVERING THIS PRODUCT, INCLUDING WARRANTIES OF MERCHANTABILITY AND FITNESS FOR A PARTICULAR PURPOSE, SHALL APPLY TO THIS PRODUCT AS PROVIDED UNDER APPLICABLE LAW.

IF ANY PRODUCT TO WHICH THIS LIMITED WARRANTY APPLIES IS A "CONSUMER PRODUCT" UNDER THE MAGNUSON-MOSS WARRANTY ACT (15 U.S.C.A. §2301, ET SEQ.) OR OTHER APPLICABLE LAW, THE FOREGOING DISCLAIMER OF IMPLIED WARRANTIES SHALL NOT APPLY TO YOU, AND ALL IMPLIED WARRANTIES ON THIS PRODUCT, INCLUDING WARRANTIES OF MERCHANTABILITY AND FITNESS FOR THE PARTICULAR PURPOSE, SHALL APPLY AS PROVIDED UNDER APPLICABLE LAW.

Other Conditions

This limited warranty gives you specific legal rights, and you may have other rights which vary from country to country or state to state.

This limited warranty is void if (i) the label bearing the serial number of this product has been removed or defaced, (ii) the product is not distributed by Kramer Electronics or (iii) this product is not purchased from an authorized Kramer Electronics reseller. If you are unsure whether a reseller is an authorized Kramer Electronics reseller, please visit our Web site at www.kramerelectronics.com or contact a Kramer Electronics office from the list at the end of this document.

Your rights under this limited warranty are not diminished if you do not complete and return the product registration form or complete and submit the online product registration form. Kramer Electronics thanks you for purchasing a Kramer Electronics product. We hope it will give you years of satisfaction.

KRAMER



SAFETY WARNING

Disconnect the unit from the power supply before opening and servicing

For the latest information on our products and a list of Kramer distributors, visit our Web site to find updates to this user manual.

We welcome your questions, comments, and feedback.

www.kramerAV.com
info@kramerAV.com